

Quality of Service in IP Networks: An Experimental Approach

The global outcomes of this project consist of the following:

- Analyze the constraints of applications such as video transmission
- Analyze the impact of traffic shaping
- Deploy a DiffServ architecture and tune the configuration parameters
- Analyze the impact of QoS mechanisms in congestion scenarios

The description of the project and the tasks is available for download on Moodle.

-. Hardware



Figure 1. GL-iNet 6461 wireless router



Figure 2. TP-Link WR741nd wireless router

-. Software

The following tools can help in assessing the QoS on the platform:

- Install and compile netperf:

```
wget https://github.com/HewlettPackard/netperf/archive/master.zip
unzip master .zip
cd netperf-master/
./configure --enable-demo=yes
make
make install
```

- Install matplotlib and fping

```
apt-get install fping
apt-get install python-qt4
pip install matplotlib
```

Install flent

```
pip install flent
```

- Install VLC as in this [tutorial](#).

-. Addressing

The addressing plan of the platform is shown in Fig. 3. Both routers have static addresses on their wan and lan interfaces. DHCP is activated on the LAN interfaces and static leases are configured so as to obtain the addresses on the terminals according to the figure.

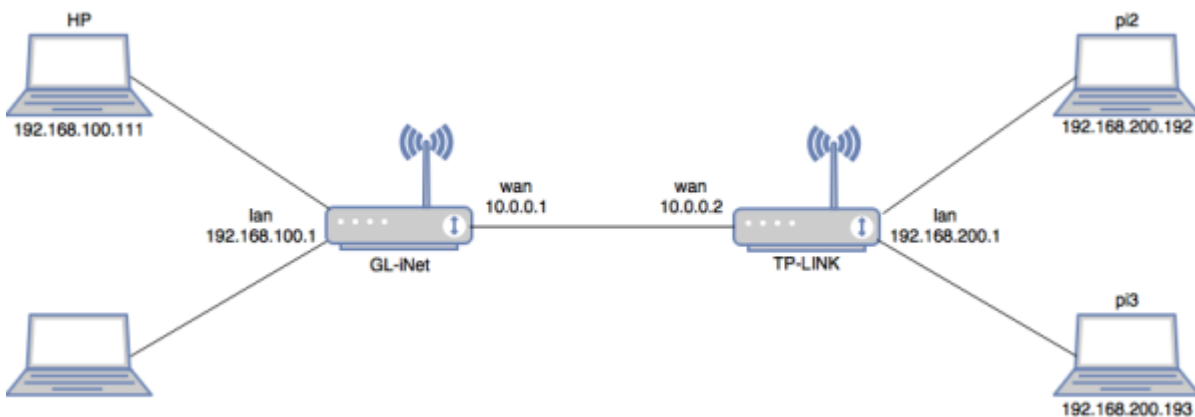

Figure 3. Addressing plan for QoS platform

-. Access and Configuration

SSH is activated on the two Raspberry Pi devices connected to the TP-LINK router. Thus, they can be accessed by typing `ssh -l pi ip_address` on any terminal. The default password is `raspberrypi` and the `pi` user is a sudoer. For advanced debugging, an HDMI cable is available so you can connect the Pi to a display monitor.

For both routers, SSH is also activated, and they can be accessed by any SSH client on the platform. For easiness, you can also connect to the WiFi interfaces (OpenWrt and GL-iNet SSID) and configure the routers from your personal laptop. The root password for GL-iNet is `helloWorld`, while no password is set for OpenWrt.



Before you leave, make sure to go through the following steps.

- Gracefully shutdown the raspberry pi modules with `shutdown -h now`.
- Switch off the TP-LINK and remove the USB power cable from the GL-iNet.



- Power off the laptop.

-. [CO1] Connecting the Platform

Describe and analyze the basic steps for ensuring the platform connectivity: addressing and routing



- Accomplished
 - Enable end-to-end communication
 - Analyse the addressing and routing (routing tables, DHCP, etc.)
- Exceeded
 - Identify the necessary commands and configurations for enabling end-to-end communication

In order to analyse the addressing and routing on the platform, we need to look carefully on the interface configuration and routing tables of the different devices.

Let us start with the routing devices. The routing table of the GL-iNet is shown using the command `ip route` and gives the following:

```
10.0.0.0/24 dev eth0 proto kernel scope link src 10.0.0.1 # loopback
address
192.168.8.0/24 dev wlan0 proto kernel scope link src 192.168.8.1 #
connection to the wifi interface
192.168.100.0/24 dev eth1 proto kernel scope link src 192.168.100.1 #
connection to the LAN 192.168.100.0/24
192.168.200.0/24 via 10.0.0.2 dev eth0 proto static # static route to the
192.168.200.0/24 network via the interface
10.0.0.2 of the TP-LINK router
```

Similarly, the routing table of the TP-LINK router shows the following:

```
10.0.0.0/24 dev eth1 src 10.0.0.2 # connection to directly connected
network 10.0.0.0/24
192.168.100.0/24 via 10.0.0.1 dev eth1 # static route to the network
192.168.100.0/24 via the interface
10.0.0.1 of the GL-iNet router
192.168.200.0/24 dev br-lan src 192.168.200.1 # connection to our LAN
192.168.200.0/24
```

We note on the two routers that static routes are used in order to give access to the two LANs. Particularly, the configuration of the routers is given in the `/etc/config/network` files as on a typical OpenWrt system.

As given below, the configuration of the TP-Link router shows the static addressing of the interface `eth0` (LAN interface) and the interface `eth1` (WAN interface). We also note the section `route` that

configures a static routers towards the LAN connected to the TP-LINK router.

[/etc/config/network](#)

```
#Configuration of LAN interface:
config interface 'lan'
    option type 'bridge'
    option ifname 'eth0'
    option proto 'static'
    option ipaddr '192.168.200.1'
    option netmask '255.255.255.0'
    option ip6assign '60'

#Configuration of WAN interface:
config interface 'wan'
    option ifname 'eth1'
#    option proto 'dhcp'
    option proto 'static'
    option ipaddr '10.0.0.2'
    option netmask '255.255.255.0'

#Configuration of the static route :

config route
    option interface 'wan'
    option target '192.168.100.0'
    option netmask '255.255.255.0'
    option gateway '10.0.0.1'
```

Similarly, the configuration of the GL-iNET router below shows the following:

- The WiFi interface is configured with a static IP address 192.168.8.1/24
- The WAN interface is configured with a static IP address 10.0.0.1/24
- A static route enables GL-iNET to reach the network 192.168.200.0/24 via 10.0.0.2 of the other router.

[/etc/config/network](#)

```
config interface 'lan'
    option force_link '1'
    option proto 'static'
    option ipaddr '192.168.8.1'
    option netmask '255.255.255.0'
    option ip6assign '60'
    option _orig_ifname 'eth1'
    option _orig_bridge 'false'

config interface 'wan'
    option ifname 'eth0'
    option hostname 'GL-iNet-b2d'
```

```
option proto 'static'  
option ipaddr '10.0.0.1'  
option netmask '255.255.255.0'  
  
config route  
option interface 'wan'  
option target '192.168.200.0'  
option netmask '255.255.255.0'  
option gateway '10.0.0.2'
```

The two routers allocate IP addresses using DHCP. In order to facilitate the usage of the platform, fixed allocations are configured for the end hosts. This is configured in /etc/config/dhcp on each router as in the following.

```
config dhcp 'lan'  
option interface 'lan'  
option start '100'  
option limit '150'  
option leasetime '12h'  
option dhcpv6 'server'  
option ra 'server'  
  
config host  
option name 'pi2'  
option mac 'b8:27:eb:0f:f8:95'  
option ip '192.168.200.192'  
  
config host  
option name 'pi3'  
option mac 'b8:27:eb:20:aa:54'  
option ip '192.168.200.193'
```

Finally, we verify the routing and addressing on the Raspberry Pi devices using `ifconfig` (or `ip addr show`) and `ip route` commands.

```
pi@raspberrypi:~ $ ifconfig  
eth0      Link encap:Ethernet  HWaddr b8:27:eb:0f:f8:95  
          inet addr:192.168.200.192  Bcast:192.168.200.255  
Mask:255.255.255.0  
          inet6 addr: fdd5:bc83:a776:0:2377:1496:eb81:1433/64 Scope:Global  
          inet6 addr: fe80::20ae:134e:ae88:4bc5/64 Scope:Link  
          inet6 addr: fdd5:bc83:a776::192/128 Scope:Global  
UP BROADCAST RUNNING MULTICAST  MTU:1500  Metric:1  
RX packets:1216 errors:0 dropped:3 overruns:0 frame:0  
TX packets:983 errors:0 dropped:0 overruns:0 carrier:0  
collisions:0 txqueuelen:1000  
RX bytes:229130 (223.7 KiB)  TX bytes:121127 (118.2 KiB)
```

```
pi@raspberrypi:~ $ ip route
```

```
default via 192.168.200.1 dev eth0 metric 202
192.168.200.0/24 dev eth0 proto kernel scope link src 192.168.200.192
metric
202
```

-. iperf tool

Let us start with the application iperf. In the following, we present a short tutorial on the main functions of the perf tool.

- To launch iperf3:
 - On the server side: `iperf3 -s`
 - On the client side: `iperf3 -c 192.168.200.192`, where 192.168.200.192 is the IP address of the server.
- By default, the traffic sent by iperf uses TCP. In order to send UDP traffic with a specific bandwidth:
 - On the client side: `iperf3 -c 192.168.200.192 -u -b 2M`

Here we set the bandwidth with UDP to 2Mbit/s. Note that by default, UDP sets the bandwidth to 1Mbit/s.

- To extend the transmission time(second) as well as the number packets sent:
 - On the Client side: `iperf3 -c 192.168.200.192 -t 15`

Note that by default, iperf3 sets the time to 10 seconds.

- To use reverse mode (server sends the traffic and client receives):
 - On the Client side: `iperf3 -c 192.168.200.192 -R`
- To send multiple flows:
 - On the Client side: `iperf3 -c 192.168.200.192 -P 2 -t 60`

Here we are sending two flows for one minute (60 seconds). We note that the average rate for the two flows can be different. However, this is not a fairness issue: we only need to extend the transmit time in order to have similar throughput for the two flows.

-. Flent Tool

Let us now analyze [Flent](#) application. Flent is a network benchmarking tools which allows to easily run network tests.

- On the Server side: `netserver &`
- To sent one TCP stream from the client to the server:
 - On the Client side: `flent tcp_upload -p totals -l 60 -H 192.168.200.192 -t title2 -o test2.png`
- To send 12 TCP streams:
 - On the Client side: `flent tcp_12up -p totals -l 60 -H 192.168.200.192 -t title3 -o test3.png`

-.VLC Tool

Let us now analyze the VLC application. VLC media player is a highly portable multimedia player for various audio, video, streaming protocol.

- On the Server side: we open VLC media player : Go to media - stream - we add the desired video - Stream - Next - for the new destination we choose UDP legacy then we click on add - we add the destination IP address 192.168.100.111 (client) and the port number 1234 - next - we uncheck the active transcoding - next stream.
- On the client side: we open VLC and then we click on play, go to network and specify the network url: udp:\@\: 1234 and finally we click on play.

-. [CO3] Shaping the Traffic

We first tried to limit the bandwidth using the following command cbq but it didn't work since cbq is not installed on the HP-PC:

```
tc qdisc add dev eth1 root handle 1: cbq avpkt 1000 bandwidth 8mbit
```

On the Wan interface eth0 of the router GL-iNet, the following command is used in order to limit the bandwidth of the outgoing traffic:

```
tc qdisc add dev eth0 root tbf rate 8000kbit burst 10kb latency 50ms
```

To verify the result of the configuration we used :

```
tc qdisc ls
```

After streaming VLC traffic and iperf UDP traffic with 6mbps to visualize the impact of the used command we noticed that the offered bandwidth is still the same 100 Mbps, therefore the same configuration should be done on the router TP-Link :

```
tc qdisc add dev eth1 root tbf rate 8000kbit burst 10kb latency 50ms
```

Now the link between the two routers has a bandwidth of 8 Mbps for both the incoming and outgoing traffic on them. In order to visualize the impact on the VLC video streamed from pi3 we generated UDP traffic from pi2 with 6mbps. The VLC video is affected giving that images of the video are pixelized.

If we want to apply this feature in one direction we have to remove the limitation of the bandwidth on one of the routers(in our case we applied it on GL-iNet router):

```
tc qdisc del dev eth0 root
```

Exceeded :

We run flent with VLC and we noticed that the video wasn't affected because flent uses TCP.

-. [PO2] Implementing QoS

The QoS will be implemented on the outgoing interface (Wan) of the router TP-Link. First, we have to check the existing configuration, on the router by typing the following command :

```
tc qdisc ls
```

To delete the previous configurations we can use :

```
tc qdisc del dev eth1 root
```

Traffic classification and scheduling : The scheduler we will be using is the Hierarchical fair-service curve (HFSC). We start by creating a common class for all types of traffic. The used commands for this are:

```
tc qdisc add dev eth1 root handle 1: hfsc default 20
```

```
tc class add dev eth1 parent 1: classid 1:1 hfsc sc rate 8000kbit ul rate 8000kbit
```

Supposing we have two types of traffic: Video UDP associated with class 1:40 running on destination port 1234, and iperf UDP with class 1:50 running on destination port 5201. In the first case, the dedicated bandwidth is $((87/100)*8000)= 6960$ Kbit and in the second case it's 1040 Kbit. The following commands are used:

```
tc class add dev eth1 parent 1:1 classid 1:40 hfsc ls rate 6960kbit ul rate 8000kbit
```

```
tc class add dev eth1 parent 1:1 classid 1:50 hfsc ls rate 1040kbit ul rate 8000kbit
```

```
iptables -t mangle -A POSTROUTING -o eth1 -p udp --dport 1234 -j CLASSIFY -set-class 1:40
```

```
iptables -t mangle -A POSTROUTING -o eth1 -p udp --dport 5201 -j CLASSIFY -set-class 1:50
```

To see the iptables commands executed on the router we can use:

```
iptables -t mangle -L
```

-. [PO3] Analyzing QoS

In this section, we have to consider different congestion scenarios: The link between the two routers will have a bandwidth of 16 Mb/s, 8 Mb/s and 5 Mb/s. For each case, we will be considering both the implementation and the absence of QoS.

1. 16Mb/s

- Without QoS:

We have to create two different classes with exactly the same bandwidth allocated for each as if no QoS is applied. The following commands are used:

```
tc class add dev eth1 parent 1:1 classid 1:10 hfsc ls rate 16000kbit ul
rate 16000kbit
```

```
tc class add dev eth1 parent 1:1 classid 1:20 hfsc ls rate 16000kbit ul
rate 16000kbit
```

```
iptables -t mangle -A POSTROUTING -o eth1 -p udp --dport 1234 -j CLASSIFY -
-set-class 1:10
```

```
iptables -t mangle -A POSTROUTING -o eth1 -p udp --dport 5201 -j CLASSIFY -
-set-class 1:10
```

```
iptables -t mangle -A POSTROUTING -o eth1 -p tcp --dport 5202 -j CLASSIFY -
-set-class 1:20
```

- With QoS: First, we have to create a common class 1:1 for all types of traffic, as before. Then, the following commands are executed in order to create two classes: 1:20 for video udp traffic with a bandwidth of $((87*16000)/100)$ and 1:30 for iperf tcp and udp traffic with a bandwidth of $((13*16000)/100)$.

```
tc class add dev eth1 parent 1:1 classid 1:20 hfsc ls rate 13920kbit ul
rate 16000kbit
```

```
tc class add dev eth1 parent 1:1 classid 1:30 hfsc ls rate 2080kbit ul rate
16000kbit
```

```
iptables -t mangle -A POSTROUTING -o eth1 -p udp --dport 1234 -j CLASSIFY -
-set-class 1:20
```

```
iptables -t mangle -A POSTROUTING -o eth1 -p udp --dport 5201 -j CLASSIFY -
-set-class 1:30
```

```
iptables -t mangle -A POSTROUTING -o eth1 -p tcp --dport 5202 -j CLASSIFY -
-set-class 1:30
```

We will be running three types of traffic:

- VLC video udp
- iperf udp traffic on destination port 5201

On the client side:

```
iperf3 -c 192.168.100.111 -u -b 50M -P 3 -t 80 -p 5201
```

- iperf tcp traffic on destination port 5202, using the following commands:

On the server side:

```
iperf3 -s -p 5202
```

On the client side:

```
iperf3 -c 192.168.100.111 -P 3 -p 5202 -t 75
```

The same commands found above are applied when configuring the link with a bandwidth of 4Mb/s and 8Mb/s.

From:

<http://wiki.lahoud.fr/> - **wikiroute**

Permanent link:

http://wiki.lahoud.fr/doku.php?id=qos_project&rev=1513670252

Last update: **2017/12/19 08:57**

